

ELECTRONIC REGULABLE SYSTEM (E.R.S.)

BMW R1200GS LC '13-'18 / RALLYE '17-'18 / EXCLUSIVE '17-'18 / ADVENTURE '13-'18

REF 9718

UPPER POSITION



PLUG&PLAY



LOWER POSITION

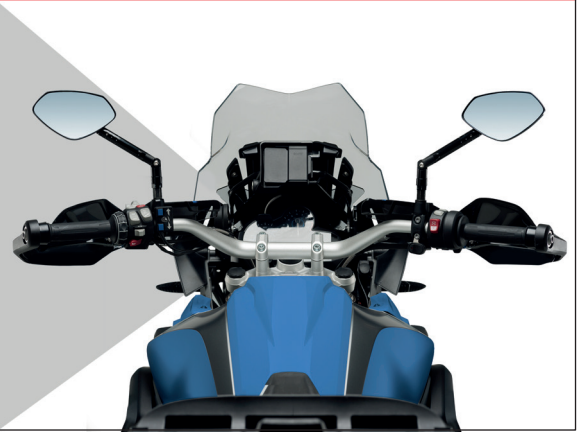

MOUNTING INSTRUCTIONS











<https://puig.tv/en/tuning-motos/windshields-lift-up-mechanism/e-r-s-electronic-regulable-screen?bike=21106>

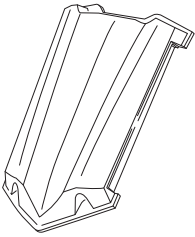
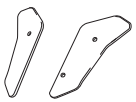
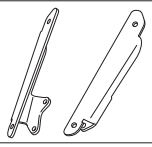
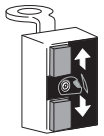
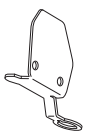
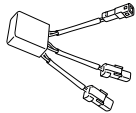

ELECTRONIC REGULABLE SYSTEM (E.R.S.)

BMW R1200GS LC '13-'18 / RALLYE '17-'18 / EXCLUSIVE '17-'18 / ADVENTURE '13-'18

REF 9718

ID	PIEZA/PART	DESCRIPCIÓN	DESCRIPTION	QTY	REF
1		Caja ERS	ERS box	1	9718
2		Deflectores	Deflectors	1	9718
3		Soportes cúpula	Screen supports	1	9718
4		Interruptor + soporte	Box switch + support	1	9718
5		Soporte toma 12V	12V Socket support	1	9718
6		Limitador de intensidad	Intensity box limiter	1	9718
7		Cable alimentación BMW	BMW power cable	1	9718
8		Tornillo Allen M5x11 Ø11 ISO7380	M5x11 Ø11 ISO7380 Allen screw	4	TORNI-AI----520
9		Silentblock Ø12xØ6x9	Ø12xØ6x9 Silentblock	4	AROPASACABLES-1
10		Casquillo con valona Ø12xØ6,8x7,3	Ø12xØ6,8x7,3 bush with flange	4	CASQUI-1A---750
11		Tapón tornillo M5 ISO 7380	M5 ISO 7380 screw cap	4	TAPON-----85
12		Tornillo Allen M5x10 DIN7991	M5x10 DIN7991 Allen screw	4	TORNI-D7991-808
13		Tornillo Allen M6x20 Ø14 ISO7380	M6x20 Ø14 ISO7380 Allen screw	3	TORNI-I7380-404

EXPLOTING

REF 9718



1 Person



60 min



MEDIUM

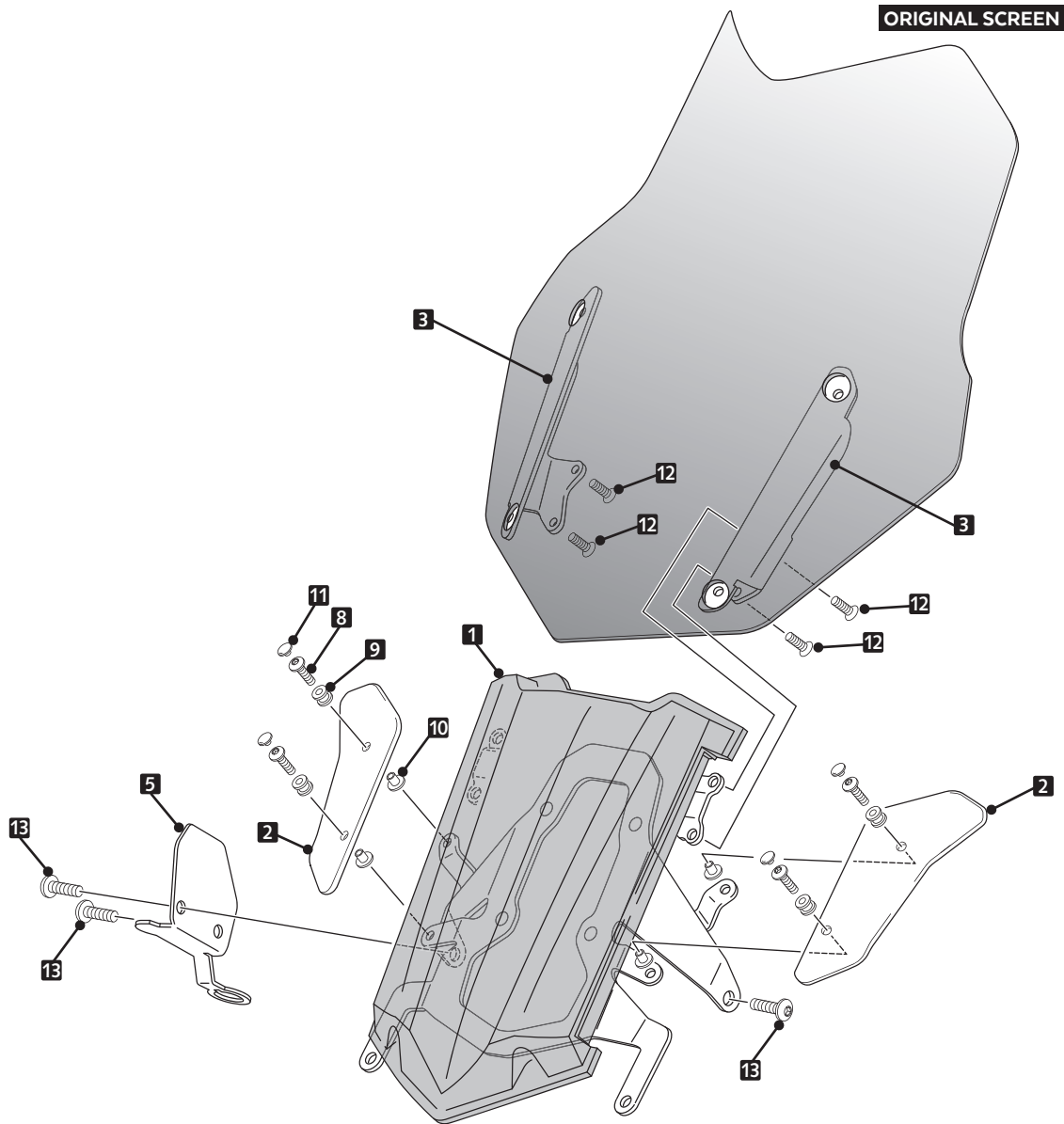

TOOLS

ALLEN
N° 3
N° 4



TORX
N° T25
N° T30
N° T40



FIX
N° 10
N° 14
N° 22



FLAT
SCREWDRIVER



CUTTING PLIERS



LONG NOSE
PLIERS



WIRING DIAGRAM

REF 9718

